

ACCESSORY DISPLAY



DISPLAY SIGN
P/N 8634-6002

P/N DISPLAY

BAND MOUNTING KITS

Lug kits



P/N	Motor Dia.	Lug Size	Bolt Circle Range
NO55L	5.5"	Large	8 ⁷ / ₈ - 12 ¹ / ₈
NO55S	5.5"	Small	6 ⁷ / ₈ - 8 ¹ / ₈
KIT34	3.3"	Large	4 ¹ / ₁₆ - 9 ⁷ / ₈
KIT50	5.0"	Large	6 ⁷ / ₁₆ - 11 ¹ / ₁₆
KIT49	3 small lugs for Kit 55S		
KIT150	4 grommets to fit lugs on Kits 49, 50, 34, 55L, 55S		



KIT150



KIT49



P/N	Motor Dia.	Lug Size	Bolt Circle Range
NO50L	4.4" & 5.0"	Large	6 ¹ / ₂ - 11 ³ / ₁₆
NO33L	3.3"	Large	4 ¹ / ₂ - 10

KIT315

Double wire band kit for 5.0" diameter motors
10.18" Bolt Circle

KIT317

Double wire band kit for 5.6" diameter motors
10.18" Bolt Circle



FAS MOUNT BRACKET KITS

P/N FM50

Motor Dia. 5.0"
Bolt Circle 9" and 10.18"

P/N FM55

Motor Dia. 5.5"
Bolt Circle 9" and 10.18"

These kits are designed for direct drive blower motors using the flexible bracket mounting arrangement.

Grommets and eyelets are included

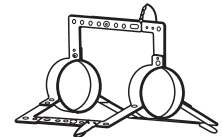

FM55 replaces this type bracket

CONDUIT KITS

KIT100

For 5¹/₁₆" and 3³/₈" GREENFIELD (flexible conduit)

Packaged two per kit



KIT102

3³/₈" Conduit Connector. Allen Stevens type, complete with mounting screws.

Packed three per kit



CONDUIT BOXES

KIT142

Black, for 3.3" dia. motors

Packaged one per kit



KIT144

Gray, tie-rod mountable conduit box for 4.4", 5.0" and 5.6" diameter motors

Packaged one per kit



BLOWER ACCESSORIES

Inlet Screens

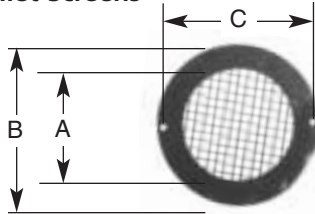

4004
A = 3.125
B = 4.50
C = 4.188

4000
A = 4.72
B = 6.125
C = 5.75

INLET 4004

for Air Rotors of less than 3 7/8" diameter Inlet 4004 can be used on the following blowers:

50746-D500, 50747-D230, 50747-D401, 50747-D500, 50747-D600, 50748-D500, 50748-D700, 50752-D230, 50752-D500, A069, A071, A073, A075, A081, A083, B23617, B23618

Packaged one per kit

INLET 4000

for Air Rotors of 4" to 5 1/2" diameter Inlet 4000 can be used on the following blowers:

50755-D230, 50755-D500, 50756-D230, 50756-D500, 50757-D500, A159, A161

Packaged one per kit

Blower Flanges

Any flange below may be used on blower models 50747-D600, 50748-D700, B23617, B23618, A073, A081.



Flange **KIT280**
Mtg. Hole Dia. .281"
Packaged one per kit

Flange **KIT282**
Mtg. Hole Dia. .136"
Packaged one per kit



Flange **KIT284**
Packaged one per kit

RESILIENT MOTOR BASES



Extra Base Clamps
CLAMP6004

Two base clamps ship with each base.

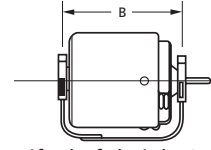

-specify shaft height 3.00" or 3.50" and motor model.

RESILIENT MOUNTING BASE INDEX

Fasco Model No.	Recomm. Base	Fasco Model No.	Recomm. Base	Fasco Model No.	Recomm. Base	Fasco Model No.	Recomm. Base	Fasco Model No.	Recomm. Base
D112	517*	D333	354*	D717	558*	D831	705*	D970	558*
D117	386	D336	435	D718	479	D834	479	D971	517*
D148	354	D337	435	D721	461	D838	558*	D972	479
D150	492*	D338	492	D723	492	D839	558*	D973	461
D151	492*	D339	492	D725	461	D840	479	D975	461
D154	558	D347	386	D726	558*	D846	558*	D981	492*
D156	461*	D354	479	D727	479	D860	595*	D1002	435*
D158	479	D356	408	D728	595	D866	558*	D1014	408
D160	461	D382	386	D729	595	D869	461	D1015	408
		D434	517*	D730	595	D870	542	D1016	479
D164	461*	D435	517*	D732	517*	D877	435	D1018	479
D166	461*	D480	542	D733	479	D879	479	D1033	461
D174	408	D481	542	D735	558*	D891	517*	D1042	492
D178	408	D482	479	D737	492*	D896	435	D1061	492
D224	435	D483	479	D739	479	D897	435	D1065	408*
D236	408	D484	479	D745	558	D902	558*	D1086	408*
D245	542	D485	479	D746	492*	D910	595	D1745	558
D247	479	D486	517*	D747	517*	D911	558	D1748	461
D249	354	D487	517*	D748	461	D912	479	D1749	461
D250	408	D490	558	D780	492*	D913	479	D1853	479
D252	354	D491	558	D782	479	D915	595	D1910	595
D253	354	D492	558	D783	461	D916	595	D1911	558
D254	408	D493	558	D784	558	D918	479	D2816	NONE
D255	408	D494	492	D785	517*	D920	595	D2817	595*
D256	461*	D495	492	D786	595	D923	479	D2818	NONE
D257	408	D496	517*	D787	479	D924	479	S2846	705
D258	435	D497	517*	D788	558	D926	479	S2848	NONE
D260	479	D635	408	D804	705	D927	435	S156	435
D264	408*	D655	408	D807	435	D928	435		
D277	479	D656	461*	D812	479	D929	558*		
D290	408*	D658	479	D814	435	D930	558*		
D312	492	D701	558*	D816	461	D935	558		
D314	517*	D703	558	D818	NONE	D937	461		
D316	461*	D710	492*	D825	705*	D939	461		
D329	408	D711	595			D951	558*		

Cradle Base "B" Dimension	3 1/2" Base No.	3" Base No.
3.54	35-354	30-354
3.86	35-386	30-386
4.08	35-408	30-408
4.17	35-417	-
4.35	35-435	30-435
4.61	35-461	30-461
4.79	35-479	30-479
4.92	35-492	30-492
5.17	35-517	30-517
5.42	35-542	30-542
5.58	35-558	30-558
5.95	35-595	30-595
7.05	35-705	30-705



P/N 35-417

NOTE: The current base numbering system is: First two numbers indicate shaft height (30 is 3.0" and 35 is 3.5" shaft height). Last three numbers represent distance between cradle arms (386 is 3.86" - 35-386 is 3 1/2" shaft height and 3.86" B dimension). To achieve the shaft height listed, the 2 1/2" diameter rings must be used.

For motors not listed : Add .8 to "A" dimension of 4 7/16" diameter motors for base "B" dimension
Add .9 to "A" dimension of 5" diameter motors for base "B" dimension
Add .5 to "A": dimension of 5 5/8" diameter motors for base "B" dimension

*May need to reverse one or more mounting rings

END SHIELD KITS

For 3.3" Diameter Motors



KIT216

Special End Plate for 3.3" Diameter Motors For Base Mounting
Use with Kit 180 Mounting Rings (see page 94)
Packaged one per kit



KIT225

Triangular bracket with grommets for 3.3" diameter motors
Packaged one per kit

Mounting Cup



KIT265

Used to mount 3.3" motors to some blower housings
Packaged one per kit

For Shaft End of 48 Frame Motors



SHLD6301

Ventilated no ext. oil retainers 1/2" Sleeve Bearing



SHLD6312

Non-Ventilated no ext. oil retainers 5/8" Sleeve Bearing



SHLD6303

Ventilated with double oiling 1/2" Sleeve Bearing



SHLD6311

Ventilated no ext. oil retainers 5/8" Sleeve Bearing



SHLD6302

Non-Ventilated with double oiling 1/2" Sleeve Bearing



SHLD6304

Non-Ventilated no ext. oil retainers 1/2" Sleeve Bearing



KIT410

End Shield caps for 48 frame 10 per kit (5 open, 5 closed)

MOUNTING ADAPTER KITS & PARTS

Mounting Kits



KIT200

Holes for 4.4" and 5.6" Dia. Motors
One kit will adapt both ends of motor for base mounting



KIT199

Motor length adapter kit. Provides means to base mount
Fasco 5" dia. motors
Two kits needed to adapt both ends of motor for base mounting



KIT380

Rheem mounting adapter plate
Packaged one per kit



KIT214

Special End Plate for 3.3"
Diameter D401 motor. For
Mounting To Comfort Air Units
Packaged one per kit



KIT218

Aluminum stand-off bracket for
motor-blower mounting. Matches
3.3" mounting pattern.
Kit 214 required to mount to motor.
Packaged one per kit



KIT204

J-frame casebolt adapter
Packaged one per kit

Adapter Plates

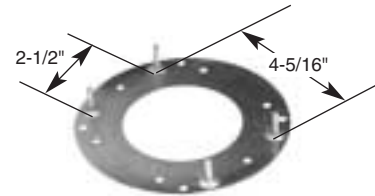

KIT207

Provides rectangular mounting stud pattern on 5.0" or 5.6"
diameter Fasco Motors to match Fedders stud motors. Similar
to Emerson and RMR rectangular mounting stud patterns
Packaged one per kit



KIT205

Franklin Redmond 4 1/8" diameter mounting adapter plate
Packaged one per kit

Adapter Kits

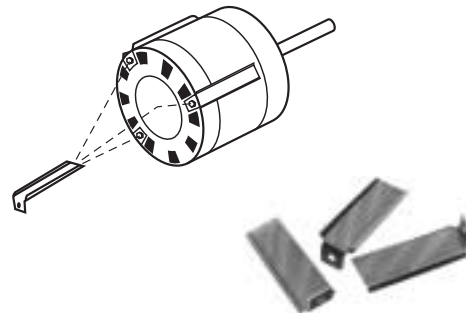

KIT538

Mounting Adapter. Enables 5" motors to replace 5-3/8" (RmR)
motors. Three adapters included in kit. Adapters increase the
mounting diameter by 3/8" for belly band mounting.

MOUNTING ADAPTER KITS & PARTS

Rheem Mounting Cables



P/N	Length	Motor H.P.
KIT325	3/4	1/6
KIT350	3/2	1/4
KIT378	3/8	1/3

Special mounting cables for Rheem. Four per pkg.



H33

Special Mounting Kit for 3.3" Diameter to Replace Motors in Nu-tone Units. Includes 4 Nuts and 2 Hex Hub Brackets. Use Kit 187 mounting rings



KIT414

Adjustable casebolt mounting kit. 4 bolt adapters per kit

Coleman "Lord" Mount

MNT1518

Stud: 1/4 x 8-32
Hole: 1/4 x 8-32
Bushing: 1/2 x 1/2
Shipped individually



KIT208

Studs: 3/8" x 8-32 x 3/8"
Bushing: 1/2" x 1/2"
4 per kit



Mounting Grommets

GROM6008

For 3/4" Slot
Shipped individually

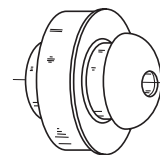

Includes a Steel Sleeve

GROM6000

For 1/2" Slot
Shipped individually

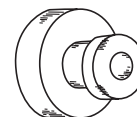

RUBBER MOUNTING RINGS

For 5.6", 5.0" and 4.4" Dia. Motors

KIT184

Henrite 2.50
Packaged two per kit



KIT183

Henrite 2.25 O.D.
Packaged two per kit



KIT186

All Rubber 2.50 O.D.
Packaged two per kit



For 3.3" Dia. Motors

KIT180

Henrite 1.80 O.D.
Packaged two per kit



KIT187

Rubber mounting rings; use with H33 in Nutone and Broan applications
Packaged two per kit



Henrite are rubber mounting rings with steel band, used with cradle bases and knife edge motor supports. All Rubber rings are used with direct drive blower motors and "Clamp" type supports

CAPACITORS



P/N	RATING		STYLE
6100-6028*	2 mfd	370V	Oval
6100-9020*	3 mfd	370V	Oval
6100-9006*	4 mfd	370V	Oval
6100-6080†*	5 mfd	370V	Oval
6100-9085*	5 mfd	440V	Oval
6100-9010*	6 mfd	370V	Oval
6100-6082†*	7.5 mfd	370V	Oval
6100-9088*	7.5 mfd	440V	Oval
6100-6083†*	10 mfd	370V	Oval
6100-6002*	10 mfd	440V	Oval
6100-6030*	12.5 mfd	370V	Oval
6100-9037	15 mfd	370V	Oval
6100-6031	17.5 mfd	370V	Oval
6100-9053	20 mfd	370V	Oval
6100-6032	25 mfd	370V	Oval
6100-6033	30 mfd	370V	Oval
6100-6034	35 mfd	370V	Oval
6100-6035	40 mfd	370V	Oval
6100-6036	45 mfd	370V	Oval
6100-6037	50 mfd	370V	Oval
6100-6038	60 mfd	370V	Oval
6100-6019	8 mfd	370V	Round
6100-6020	10 mfd	370V	Round
6100-6021	12 mfd	370V	Round
6100-6022	15 mfd	370V	Round
6100-6023	20 mfd	370V	Round
6100-6024	25 mfd	370V	Round
6100-6025	30 mfd	370V	Round
6100-6026	35 mfd	370V	Round
6100-6027	40 mfd	370V	Round

Bulked packed 100 per carton

6100-6119*	5 mfd	370V	Oval
6100-6120*	7.5 mfd	370V	Oval
6100-6121*	10 mfd	370V	Oval

* Will fit Kit 6001

† Parts are individually boxed

MISCELLANEOUS KITS

Capacitor Mounting Kit

KIT6001

Rubber Boot and Bracket

RUBBERBOOT

Rubber Boot Sold Separately



Staked Tie Rods Qty. 4

KIT220

8" long 8-32 NC for Fasco 5.6" Dia. motors

KIT221

8" long 10-32 NC for Fasco 4.4" Dia. motors

Includes 1 Staked Nut and 1 Regular Nut



KIT832

8-32 Nuts, 32 pieces



KIT1032

10-32 Nuts, 32 pieces



MISCELLANEOUS KITS (continued)

Neoprene Gasket

1 gasket
GASKET0167
 Includes 4 grommets



Water Slinger

SLINGR6002
 1/2" I.D. 2" O.D.
 Shipped individually



Shaft Bushings Qty. 4

KIT240
 1/4" ID x 5/16" OD
KIT242
 3/8" ID x 1/2" OD
KIT244
 5/16" ID x 3/8" OD
KIT246
 1/2" ID x 5/8" OD



Rain Shields

KIT170
 For 1/2" Shaft Dia. Motors
RAIN6000
 For 5/8" Shaft Dia. Motors



KIT465
 Anderol 465 synthetic
 lubricating oil
 Packaged one per carton



Cooling Fan Kit for Draft Booster Motors

P/N FK100
 C.W. Rot. 1 3/4" Dia.
 1/4" Hub I.D.
P/N FK101
 C.C.W. Rot. 1 3/4" Dia.
 1/4" Hub I.D.
 Shipped one fan per kit



Rotation is facing
 side opposite hub